

The REV Project



ELEC3330 Final Report

Electronic Differential System

Jonathan Eng 20263557

10/27/2009

Supervisor: Thomas Braunl

Details of the implementation of an Electronic Differential System in the REV SAE car.



Table of Contents

1) Introduction	3
Differential	3
Electric Motor	4
Sensors.....	4
Motor Controller.....	5
2) Work Done	6
The Problem.....	6
Microcontroller	6
Pedals.....	6
<i>Figure 2.1</i>	7
Steering Wheel.....	7
Others	8
3) Conclusion	10
4) Results	11
<i>Figure 4.1</i>	11
Figure 4.2	11
Figure 4.3	12
Figure 4.4	12
Figure 4.5	13
Figure 4.6	14
Figure 4.7	15
5) Further Work	16
6) Appendix	17
7) Reference	22



Introduction

Differential

The definition of a mechanical differential is one that helps with the transmission of torque to the wheels while allowing various speeds and torque to occur on both wheels simultaneously, depending on the amount of friction/force present on the wheels and the road surface. As such, this mechanical device allows the wheels to rotate at different speeds especially when the vehicle is turning around in corners. This means that the vehicle can transmit equal force on the wheels while allowing the wheels to rotate at different speeds allowing the vehicle to turn around corners without having the wheels dragging each during the turn, which occurs in vehicles without a differential. Vehicles without a differential usually have a common axel in which the transmission passes the torque equally to both wheels forcing it to rotate at the same speed, which causes the wheels to drag when going around corners.

Electronic differential on the other hand allows electrical sensors to be placed on the steering column to calculate the angle of the steering wheel as well as lateral acceleration to calculate the force of the car to help distribute the torque proportionally to allow maximum traction on the wheels. In this project the electronic differential won't be controlled by planetary gears but by having two independent electric motors to control the amount of torques and speeds on the rear wheels of the car, by taking inputs from the throttle and brake pedals and from the steering column.

The overall differential system in this project includes the three sensors, from the throttle and brake pedals and the angle of the steering column, which sends its signals to an ECU (electronic control unit) which processes the inputs and sends out a pulse width signal to the motor controllers which then powers the two onboard electric motors in the car.

This year is the first year that the REV group is designing an electric motorsports vehicle for the formula SAE competition. The Formula SAE is an international design and performance competition, run and organized by the Society of Automotive Engineers. As this is the first year of the SAE project, all the designs are in the prototype stage, meaning there is no refining done to the designs themselves if any, as well as no previous format/designs to build on from. The UWA Motorsports group also donated their 2001 vehicle to the REV group to build from.



Electric Motor

There are two main types of electric motors in the modern world, AC and DC motors. AC motors are run on an AC power supply and because of the alternating power, special more expensive hardware are needed to convert the car's batteries DC power supply to AC for the motor to run, this makes it less economically viable even though it's generally considered more efficient than DC systems. DC motors on the other hand are commercially cheaper to obtain, have efficiencies up to 90% and are also relatively easy to control with which makes it more viable an option to use than AC motors.

As we are only looking to make a prototype and use it as a bench mark, the DC brushless motor type will be used. Brushless motors have permanent magnets as their rotor and their stator coils are electronically controlled whereas normal DC brush motors have coils as their rotor and have brushes to make the connection with the commutator. There are many known problems with brushes, such as the wear of the brushes, as the brushes must be in full contact to run the motor effectively which causes friction to occur on the commutator which then wears down and requires replacement. Another known problem is at high speeds, the brushes don't maintain contact constantly which causes sparks to occur when there is a gap between the commutator and the brushes, and this makes it highly dangerous as well as inefficient for the motor to run. Brushless DC motors on the other hand solves these problems, by replacing the brushes and commutator with an electronically controlled switch that synchronises with the rotor's position, and without the brushes creating friction and limiting the efficiency of the motor the brushless motor is generally more efficient than the brush motor.

Sensors

In this project we will be considering three different types of sensors of which only two will be used. Choosing the right sensors to meet the required specifications of the project, requires careful consideration as time will be spent on constructing the right mount for the sensors to be implemented in the car, which would be wasted if the sensors chosen did not meet the specifications.

Potentiometers are basically voltage dividers that can be varied by changing the resistance inside the potentiometer by sliding the rotatable or moveable part of the potentiometer. There are various types of potentiometers ranging from linear to rotary and sub types from linear to logarithmic outputs. They can be used to measure the displacement of a



desired moveable/rotatable object, by producing a voltage signal that varies with the displacement either linearly or logarithmically.

Hall Effect sensors are transducers that varies its voltage output by a change in the magnetic field that it is in. As the magnet goes closer to the sensor, the magnetic field becomes stronger which causes the output voltage to be less and vice versa, this effect is due to the Lorentz Force. Hall Effect sensors are usually used in determining the speed of rotation of wheels, by producing a voltage that is periodic which its frequency is based on the speed of rotation. It can also be used to measure distance between points to a certain degree of accuracy, as long as there are no foreign bodies coming in-between the sensor and the magnet which could change the magnetic field between the sensor and the magnet.

Photo interrupters are basically a digital switch which produces a voltage signal when there are no obstructions between the sensors, and no signal when there is an obstruction caused by a foreign body. It detects an obstruction via infrared signals between the sensors. The main use of such a sensor are to detect an obstruction and as a counting sensor via an electronic circuit which counts the number of obstructions detected by the sensor, ie commonly used in printing machines.

Motor Controller

Motor controllers are used to control and protect the electric motor which its connected to The motor controller controls the rotational direction the motor is running via sending currents and voltages in different directions, varying and regulating the speed the motor is running at, adjusting the amount of torque present on the motor and preventing damaging voltages and currents from going into the motor.



Work Done

The Problem

The design and implementation of an electronic differential prototype system on the SAE car. Utilising the angle of the steering column as the main input in the traction system, alongside with the throttle and brake pedals to supply the appropriate signal to the motor controllers.

Microcontroller

The selection of the system's microcontroller was the first priority, selecting an appropriate microcontroller with enough analogue-to-digital converter inputs to allow more readings from the car's sensors which would help with the control of the differential system. There are many commercially available microcontrollers to choose from but the ones used in industry would allow a better exposure to the industry and the types of microcontrollers they use, as such the majority of those industries use either PIC or Amtel type chips both of which are similar and accomplishes the job just as well. The reason the Amtel microcontroller was chosen over the PIC was that I had previous exposure to Amtel's programming layout from a previous year's unit, Digital Systems. If I had gone with the PIC chips I would have needed to read up and practice programming simple programs before starting the project. As such an Amtel Atmega8 microcontroller was selected to be the main controller, and in future projects the microcontroller can be added with more microcontrollers to process the inputs and outputs of the system if need be.

Pedals

There were two choices to choose from for the sensors on the throttle and brake pedal, either implement linear potentiometers which would be mounted alongside the pedals and connected to the pedals or hall-effect sensor with the magnet on the pedal structure while the sensor is mounted onto a plexiglass mount directly behind the pedal. Installing the linear potentiometer solution would have required a moveable mount for the potentiometer to move freely in the same direction as the pedals as its pressed and released, such a solution would need to have enough space for the mount and the linear potentiometer, as the pedals are



relatively close to each other. Another disadvantage of the linear potentiometer solution is that the commercial potentiometer's themselves have a limited lifespan ranging from a few hundred thousand cycles to millions of cycles, depending on the quality of the potentiometer, before the wear affects the reliability of the readings. Implementation of the hall-effect sensors on the other hand provides a simpler, space saving and more reliable readings with longer lifespan compared to the potentiometer. However the main disadvantage of the hall-effect implementation is, if a foreign object comes in between the sensor and the magnet, depending on the characteristics of the foreign object and its size, the sensitivity and hence the reading of the sensor would be dramatically dulled. To counteract this problem, a special enclosed casing would need to be made to prevent such foreign bodies from coming in-between the sensor and the magnet, for both pedals.

For the hall-effect implementation for the pedals, two sets of permanent magnets and hall-effect sensors were used. The permanent magnets were slotted into five millimeter drilled holes which are situated sixty millimeters from the base of the pedals, while the hall-effect sensors were mounted onto small plexiglass mounts which are thirty millimeters high from the base and are placed approximately seventy millimeters behind the pedals and are within the range of the permanent magnet. See *Appendices Figure 6.1* Because of idiosyncrasies and the distance variables, both hall-effects would not give exactly the same reading for both pedals, as such the following are the voltages that are produced from the sensors;

	Stationary	Full Press
Throttle	2.6 volts	0.4 volts
Brake	2.45 volts	0.1 volts

Figure 2.1 The voltages produced from the hall-effects sensors

Steering Wheel

The steering wheel sensors had also two choices available to select from, the linear potentiometers solution or the photo interrupters implementation. With linear potentiometers, it would need to be mounted onto the steering rack that steers the two front wheels, it should be just before the tie rod, on each end of the steering rack. See *Appendices Figure 6.2* for details. As stated before linear potentiometers have a limited life span of a few hundred thousand presses and so would not be a viable option in the long run. The photo interrupters implementation on the other hand are a more viable option, they are easily obtainable and are significantly cheaper and produce a digital signal when it's implemented. The implementation of the photo interrupters requires a disk which has equally spaced cuts along the outer rim



which will be read by the photo interrupters, as an 'on' input and an 'off' input when there's an obstruction between the two sensors. See *Appendices Figure 6.3*.

To implement this solution, there is a need for some kind of system to remember the angle of the turn of the steering wheel, which will be used in determining which motor to decrease the throttle in. To solve this, utilizing two interrupters which are out of phase of each other by ninety degrees would solve the problem of which direction the steering wheel is turning as well as having a way for the microprocessor to remember how many times the sensors got interrupted which is used to calculate the angle of the turn for traction control. The two photo interrupters will be mounted onto a plexiglass mount which is connected near the end of the steering shaft, and placed 15mm apart from each other from the sensor opening. The cuts on the disk, are 4mm wide and are 4 mm spaced apart, which brings the total number of cuts on the disk to be 30, this gives a resolution of 15 counts from the central point of the steering wheel to both sides of the steering wheel. By using two photo interrupters which are 90 degrees out of phase between each other, the system will be able to have a digital state memory system where the last known position of the steering wheel is compared to the new position input of the steering wheel. See *Appendices figure 6.4 for more information*. This set up also allows a distinction of which direction the steering wheel is turning as turning the wheel right will result in the following output from the sensors, 00 -> 10 -> 11 -> 01 -> 00, while if the steering wheel turned left the outputs will result in, 00 -> 01 -> 11 -> 10 -> 00. These outputs are used as interrupts which are triggered by both a rising and falling edge to the microprocessor and are stored in the program as a variable called *oldState* which is used to compare to the next set of outputs to determine which direction and angle the steering wheel is turning.

Others

For all the inputs and outputs of the Atmel Atmega8 microprocessor, low pass filters were needed to attenuate the unwanted high frequency noise that came from the car and cross wires. The low pass filter will allow only the desired low frequency signals to pass through the system, as the outputs and analogue inputs are in the low frequency range. For this project capacitive low pass filters are implemented as they are simpler, inexpensive and exhibit less coupling with other components and are less resistive compared the inductive type. As the analogue to digital converter has a resolution of 1024bits and 8 bits wide, and so the frequency of the output PWM signals would be around the 60 Hz range, as such the desired frequency cut-off of the low pass filter should be below 6 Hz thus the low pass filters' cut-off frequency are 3.386Hz easily allowing the output signals to go through while the noise signals from the background in the car are attenuated from the signals and has a faster rise time. Thus the



resistors in the low pass filters are of a magnitude of $4.7\text{k}\Omega$ and the capacitors are in the order of $10\mu\text{F}$.

Two diodes were implemented in the circuit, one at the positive 12 volt supply input and the other connecting between the 12 volt supply and the 5 volt output of the voltage regulator in the circuit. Having the diode placed facing towards the 12 volt input of the voltage regulator ensures that the voltage travel towards the regulator under normal operation, ie the diode becomes forward biased, but when the voltage source becomes lower, the diode will shut the voltage from passing through to the voltage regulator to prevent voltage spiking should it occur. This is also why there is another diode in place connecting between the positive 12 volt supply into the regulator and the 5 volt output of the voltage regulator which prevents the regulator from supplying damaging voltage spikes to the small circuit. The diode is in reversed bias under normal operation conditions and will prevent current from passing through when the power input voltage is greater than the output of the regulator which should be 5 volts. Thus when the 12 volt power supply is disconnected from the circuit the diode turns on , so that the 5 volt regulator voltage becomes 4.3 volts and decreases over time as the capacitors discharge safely.

There is also an emergency stop button that is implemented along in the system that will disengage the circuit from sending signals to the motor-controller until the emergency stop button is reset to its initial state. The emergency button when pressed will lock itself down, to a closed switch, which will then change all the PORTB ports to become inputs in the program until the emergency button is twisted to release it back to its initial state. By preventing the circuit from sending signals to the motor-controllers the onboard motors will shut down which will allow the car to coast to a stop unless the driver brakes using the mechanical brakes.

The car will be run via two onboard Mars DC brushless motors that have the capabilities to support regenerative braking. The motor is able to perform with 90% efficiency at voltages between 24 to 48 volts in DC and has a total motor weight of 10 kg. The motors will be mounted to the rear wheels with each rear wheel having its own onboard motor, the motors will be controlled by the two Kelly KBL brushless motor controllers, one for each motor. The motor controller will take the PWM (pulse width modulation) signals from the circuit board and processes and checks it before sending the signal to the motors to powering it. The motor controller will be able to protect the motors from overheating, voltage/current spiking and overloading

The mechanical brakes are used as secondary brakes, as the onboard motors and motor-controllers have the capabilities to apply regenerative braking to the vehicle which are the primary brakes for the vehicle. There is a need to do fine tuning of the system to work with the



mechanical brakes, but that will be done after the onboard motors and batteries are mounted onto the vehicle properly. The main idea is to have the regenerative braking taking roughly 70% of the braking while the mechanical brakes does the rest of the braking. But when the emergency button is pressed and the circuit stops sending signals to the motor-controllers, the mechanical brakes becomes the main primary brakes until the emergency button is released.

Conclusion

By converting the vehicle's mechanical differential system to an electrical one, the weight of the vehicle is lighter as the heavier mechanical parts such as the axels and the differential box are replaced with a simple circuit board with light weight sensors on the steering wheel and the pedals, and the on board motors which are connected to the two rear wheels which does the job of both braking, accelerating and the even distribution of torque on the rear wheels. However the weight of the vehicle's batteries are the main contributor for the weight of the car, however as battery technology are making breakthroughs in energy storage and weight reductions electric conversions would make for a better choice as cars handle better with less weight when turning corners and would have higher power to weight ratios.

By removing the mechanical differential system and replacing it with an electronic differential, the driver is able to tune and change the amount of traction control on the wheels via the program, which opens a whole new set of customizability to the way the car handles according to the driver's preference, whereas with a mechanical differential system there are physical set restrictions to what the driver can change, such as the gear ratios between the planetary gear and the wheels. In recent car models, there is another type of differential that is electronically controlled that's called an active differential. The active differential uses the same inputs as this project as well as information from the car's shift in weight and lateral acceleration, which then distributes the torque on the wheels to prevent loss of traction on the road, like oversteer and understeer. The active differential can also be easily tunned to the driver's preferences via the car's ECU(electronic control unit).

By having an electronic differential, the vehicle's handling can be changed to the driver's preference more easily than with a mechanical differential. As such the electronic differential offer's a lot more capabilities and functionality and in some ways a higher degree of control over the distribution of torque between the wheels.

Results

The following graphs are taken from the outputs of the throttle and brakes using a digital oscilloscope, in all the graphs the PWM's are oscillating at 60Hz, with the peaks at 1.74 volts and dips at 0.11 volts. The inputs of the circuit are taken from the hall-effect sensors from the pedals which has inputs ranging from 0.1 volts to 2.6 volts. The green graph shows the throttle output of the right motor from the circuit, the yellow graph shows the throttle output of the left motor from the circuit.

The voltage inputs from the throttle are reversed in the program as the hall-effect sensors give a positive large voltage for a stationary pedal and a positive low voltage for a full press pedal, thus the program reverses it to positive low voltage for a stationary pedal and a positive high voltage for a full press pedal.

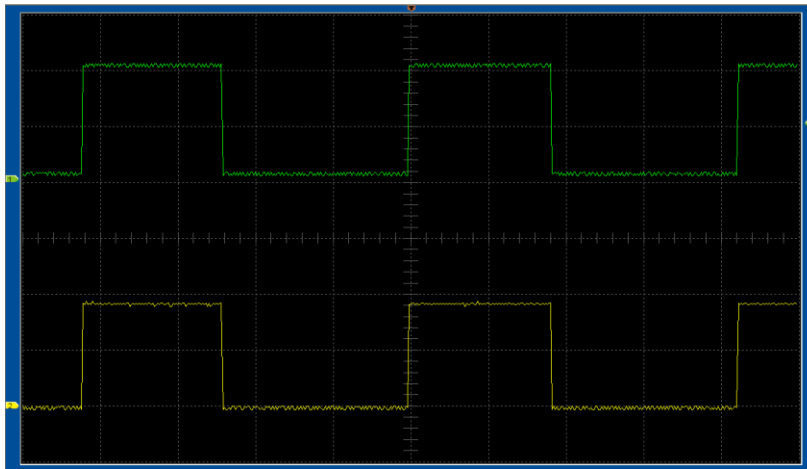

Figure 4.1- The initial graph of the throttle, where the throttle input is 1.7 volt.

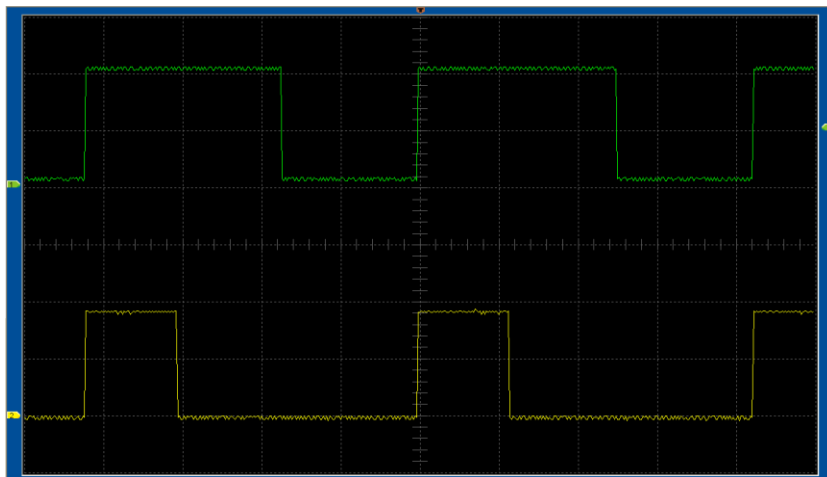

Figure 4.2 The result of the graph when the steering wheel is turned left

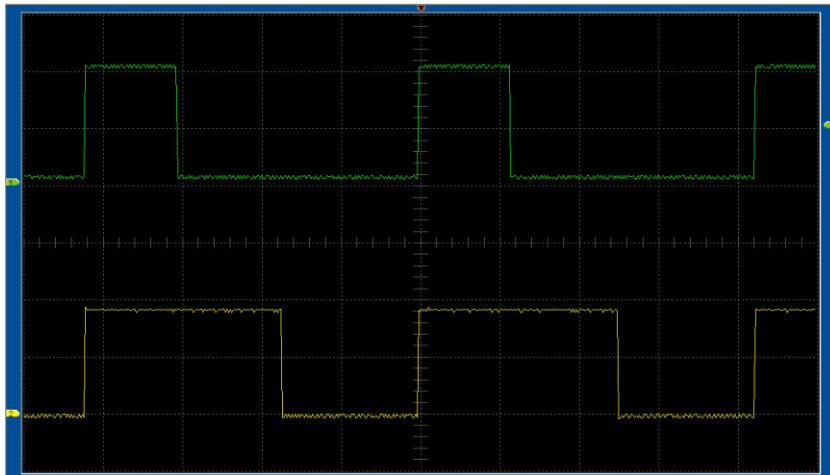

Figure 4.3 The result of the graph when the steering wheel is turned right

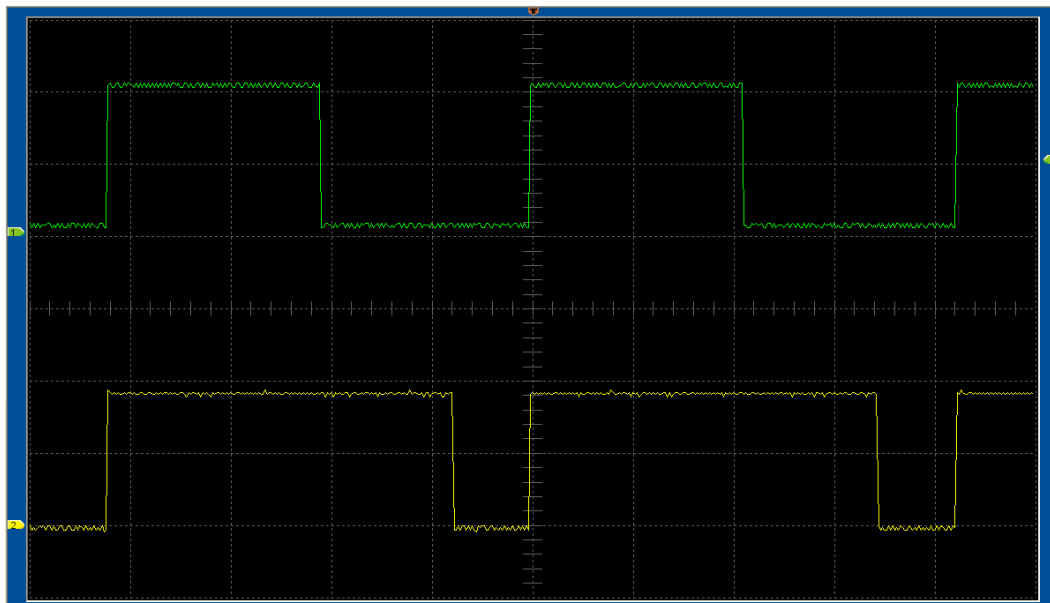

Figure 4.4 The result of the graph after the wheel is turned right and the throttle is increased from 1.7 volts to 2.616 volts.

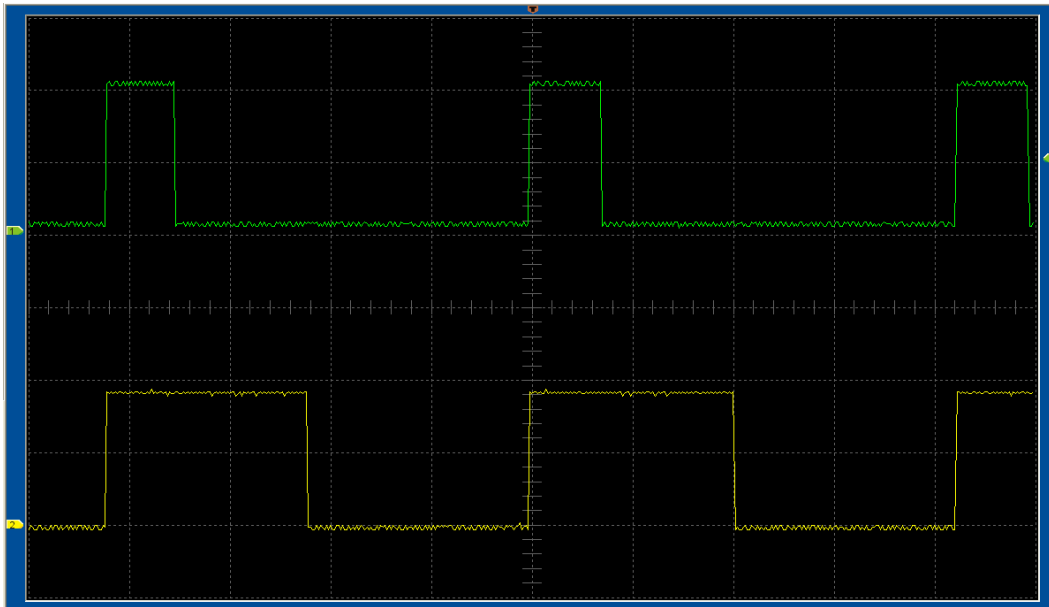

Figure 4.5 The result of the graph after the wheel is turned right and the throttle is decreased from 1.7 volts to 1.295 volts.

The following schematics are drawn on EAGLE cad software and shows the designs of the differential circuit board.

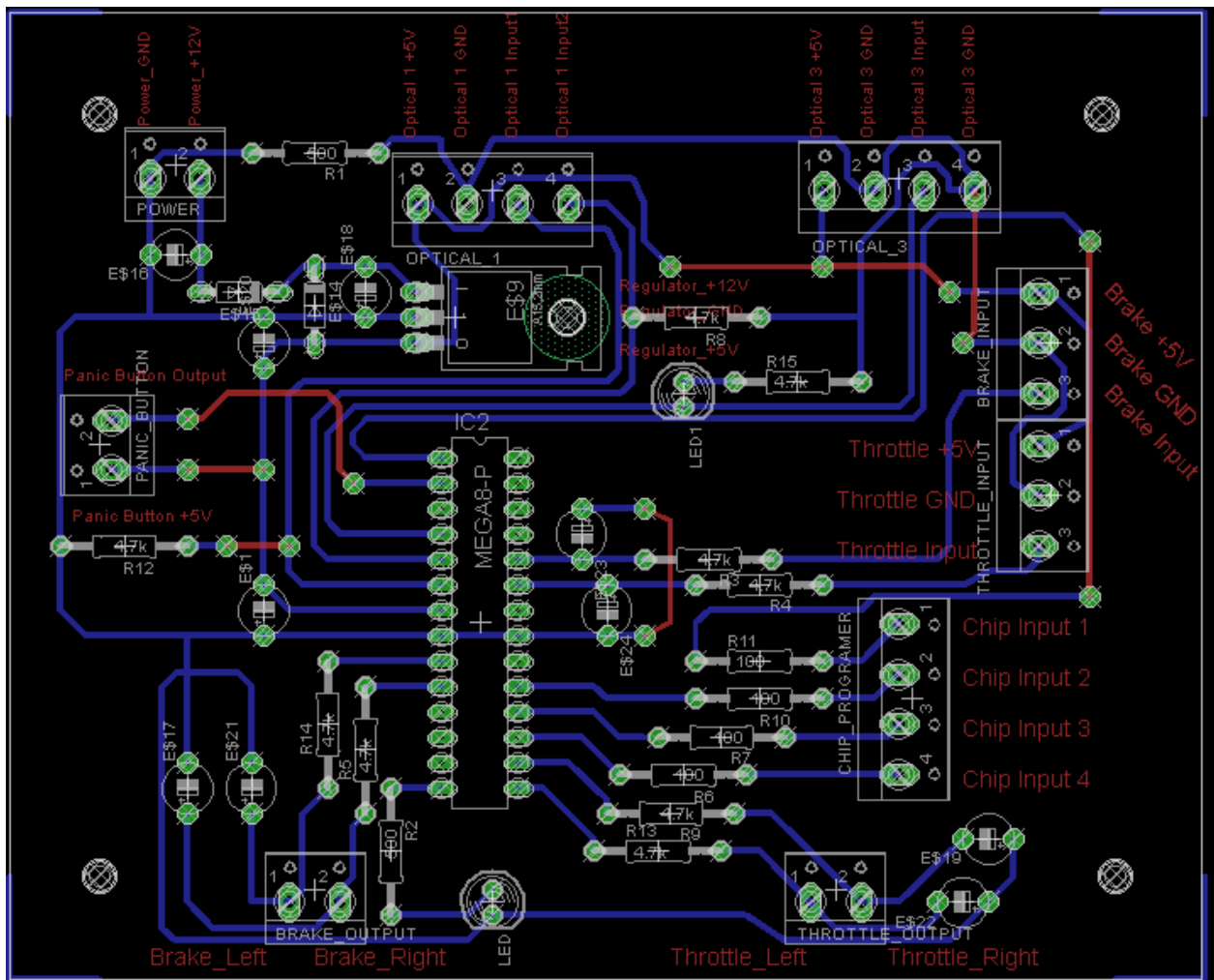

Figure 4.6 The final board design of the electronic differential, width is 9.7 cm and length is 11.8 cm

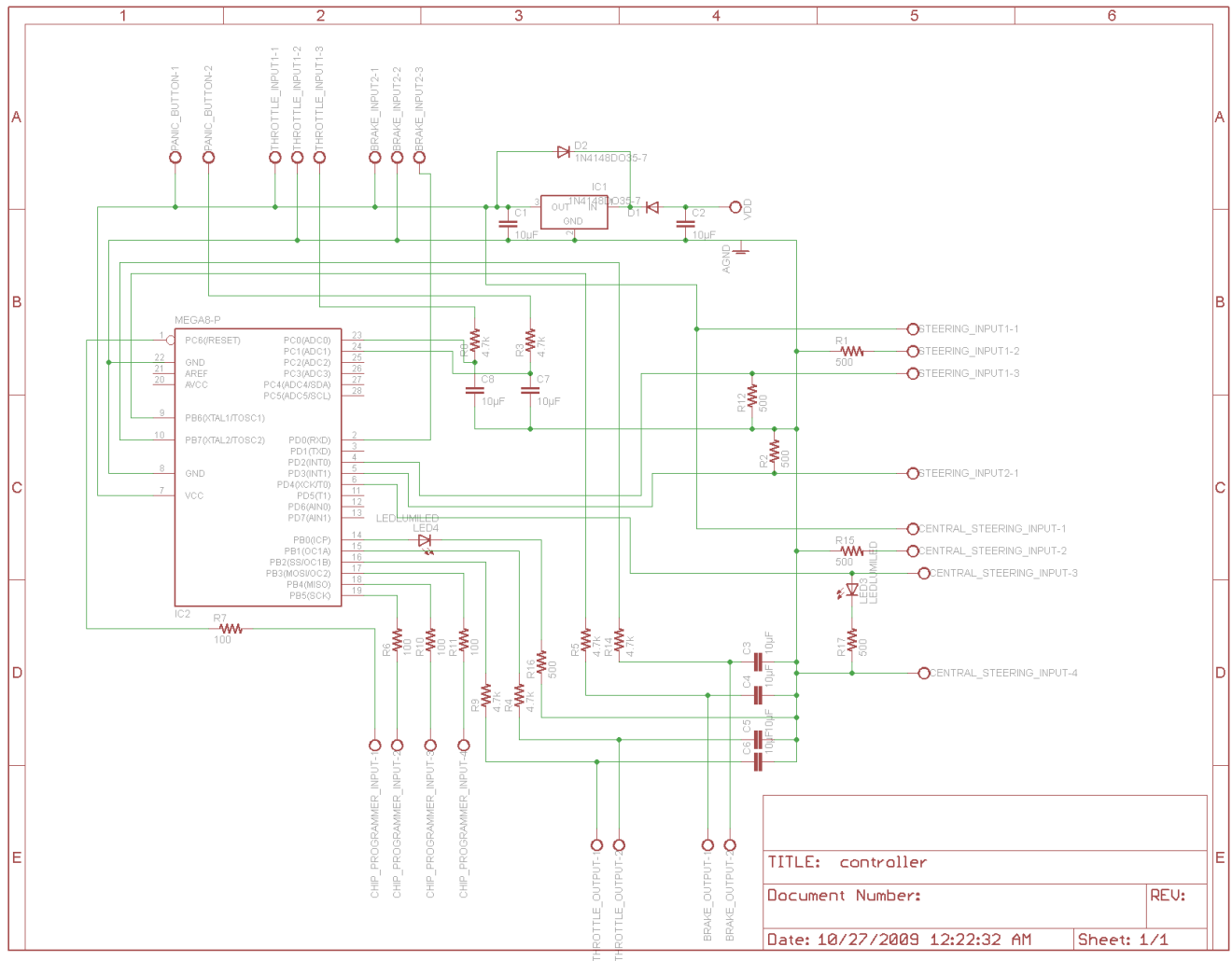

Figure4.7 The drawn schematic of the board.



Further Work

With wheel hub motors, especially on all four wheels, the electronic differential will have greater control of the traction and stability of the vehicle as the microprocessor would have direct control on the amount of torque being supplied to the wheels when operational. With the current generation of wheel hub motors, hall effects sensors and rotary encoders are pre-built into the motors allowing for more sensory inputs into the system to accurately monitor the operation of the motor. Another major advantage to the wheel hub implementation is the massive weight reduction compared to mechanical transmission and even conventional electric motors. However even with the current generation of wheel hub motors, the cost is too expensive making it not suitable for the motorsports league, but the concept is a feasible idea if the REV team manufactures their own wheel hub motors.

If the two onboard motors are used to operate the car, an addition of more sensors on the motors would give the exact rotation of the wheels and the torque, which can be used to measure the amount of grip the tires have when traveling around corners and also possibly an introduction to various modes of traction control, ie a set traction control for gravel, sand, snow and road surfaces. An implementation on of strain gauge sensors along the chassis could measure the amount of strain the chassis is under when cornering hard, which the information could be used to fine tune the traction/handling of the car.

Appendices

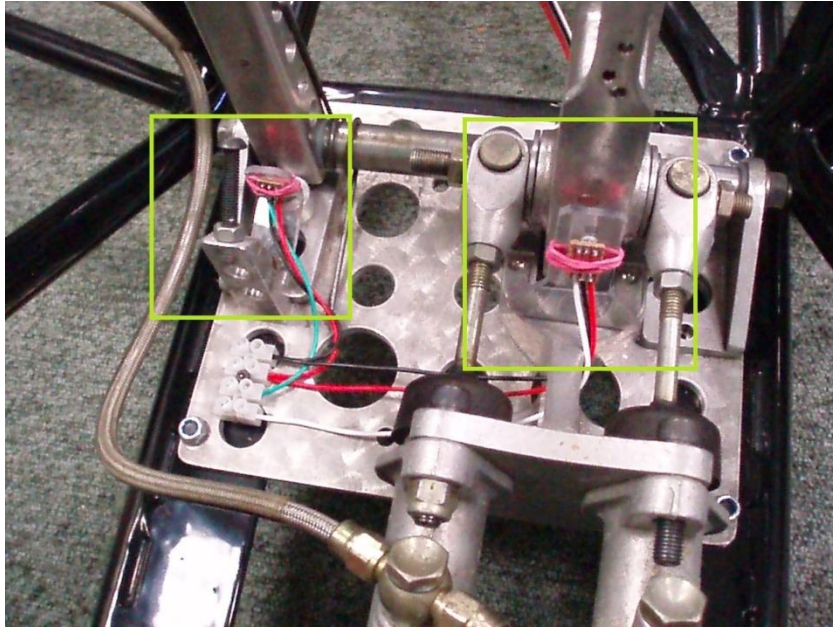

Figure 6.1 The highlighted area shows the mounts for the hall-effect sensors with its magnet in front of the sensor embedded into the pedals.

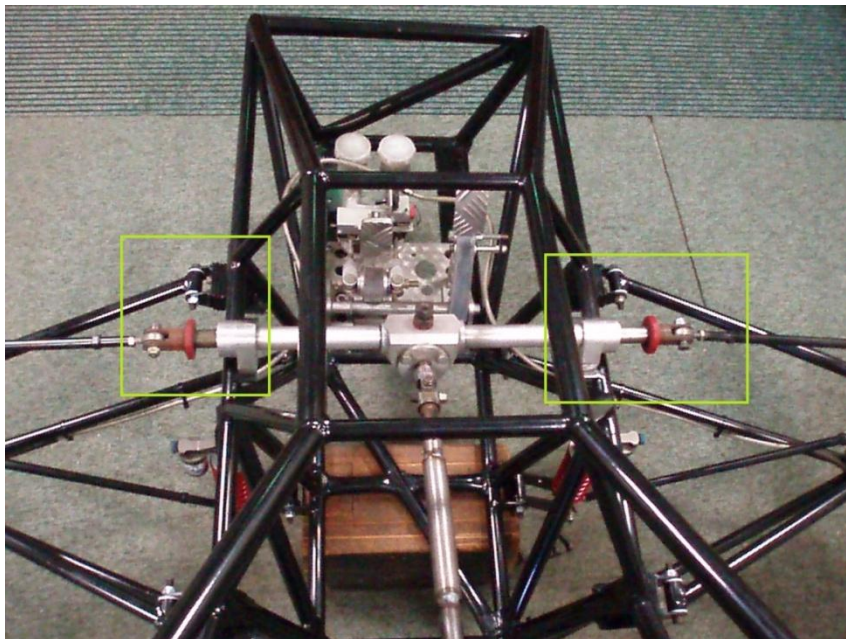

Figure 6.2: The Highlighted boxes show, where the linear potentiometers should be mounted on for the linear potentiometer solution.

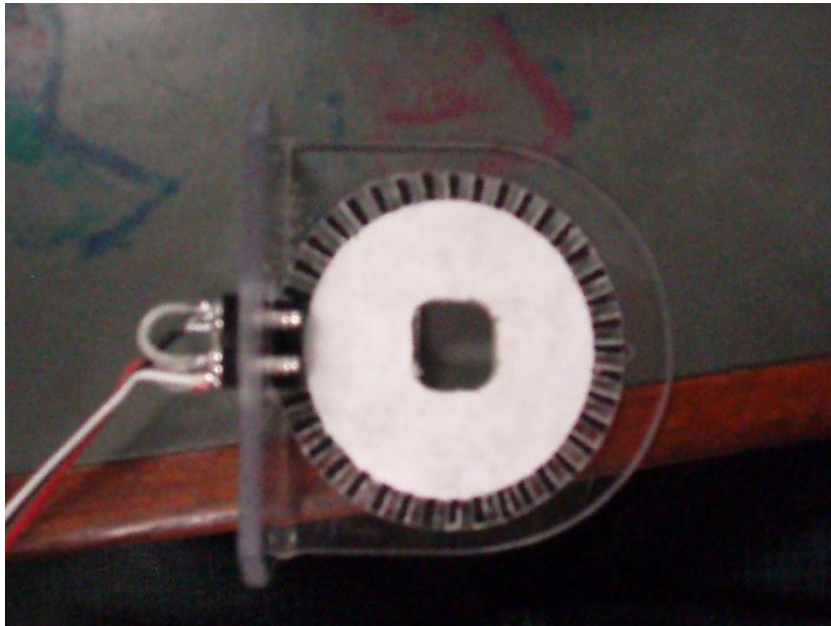

Figure 6.3 The mount of the photo interrupters and the disk with evenly cut obstructions.

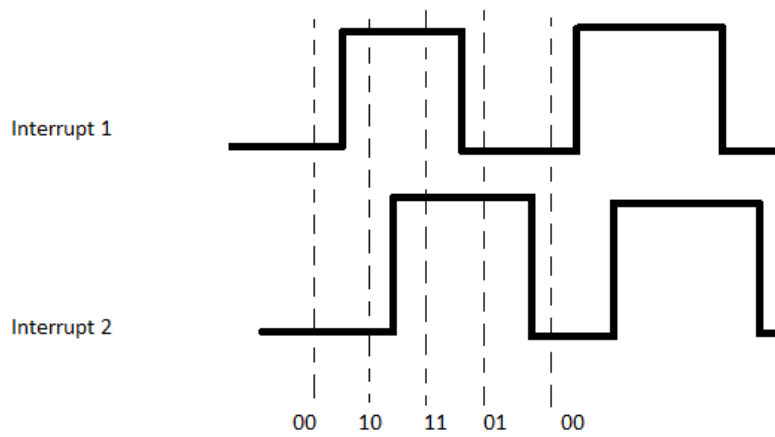

Figure 6.4: The outputs of the two photo interrupters reading from the evenly spaced cuts on the disk.



Reference

[1] E.C. Lee, "Brushless D.C, A Modern Approach To Variable Speed Drives", in Textile, Fiber and Fill Industry Technical Conference, 2-3 May 1990, pg3/1 – 3/5.

[2] Y C Chiou, J.T Kuo, J Chen, "Compact miniaturized stepped-impedance low pass filters with a broad stopband", Microwave Conference Proceedings, 2005 Asia-Pacific Conference Proceedings, Volume 3, 4-7 Dec 2005, pg 1- 4